

# MCLA1005V2

## Automotive multilayer chip inductor



### Product features

- AEC-Q200 qualified
- 0402 (1005 metric) package
- Multilayer monolithic construction yields high reliability
- Inductance range from 1.0 nH to 330 nH
- Moisture sensitivity level (MSL): 1

### Applications

- ADAS
- Infotainment
- Wireless communications
- Wifi, bluetooth, satellite
- Antennas tuning
- On board computer

### Environmental data

- Operating temperature range: -40 °C to +125 °C (ambient plus self-temperature rise)



**Product specifications**

Part number	OCL Tolerance	OCL (nH)	Q minimum	DCR@ (Ω) @ +25 °C maximum	Test frequency (MHz)	Test voltage (mV)	SRF (MHz) minimum	I Rated (mA)
MCLA1005V2-1R0-R	±0.3nH	1.0	8	0.1	100	50	10000	400
MCLA1005V2-1R1-R	±0.3nH	1.1	8	0.1	100	50	10000	400
MCLA1005V2-1R2-R	±0.3nH	1.2	8	0.1	100	50	10000	400
MCLA1005V2-1R3-R	±0.3nH	1.3	8	0.1	100	50	10000	400
MCLA1005V2-1R5-R	±0.3nH	1.5	8	0.1	100	50	6000	300
MCLA1005V2-1R6-R	±0.3nH	1.6	8	0.12	100	50	6000	300
MCLA1005V2-1R8-R	±0.3nH	1.8	8	0.12	100	50	6000	300
MCLA1005V2-2R0-R	±0.3nH	2.0	8	0.15	100	50	6000	300
MCLA1005V2-2R2-R	±0.3nH	2.2	8	0.15	100	50	6000	300
MCLA1005V2-2R4-R	±0.3nH	2.4	8	0.15	100	50	6000	300
MCLA1005V2-2R7-R	±0.3nH	2.7	8	0.15	100	50	6000	300
MCLA1005V2-3R0-R	±0.3nH	3.0	8	0.2	100	50	6000	300
MCLA1005V2-3R3-R	±0.3nH	3.3	8	0.2	100	50	6000	300
MCLA1005V2-3R6-R	±0.3nH	3.6	8	0.2	100	50	4000	300
MCLA1005V2-3R9-R	±0.3nH	3.9	8	0.2	100	50	4000	300
MCLA1005V2-4R3-R	±0.3nH	4.3	8	0.2	100	50	4000	300
MCLA1005V2-4R7-R	±0.3nH	4.7	8	0.25	100	50	4000	300
MCLA1005V2-5R1-R	±0.3nH	5.1	8	0.25	100	50	4000	300
MCLA1005V2-5R6-R	±0.3nH	5.6	8	0.25	100	50	4000	300
MCLA1005V2-6R2-R	±0.3nH	6.2	8	0.3	100	50	3900	300
MCLA1005V2-6R8-R	±5%	6.8	8	0.3	100	50	3900	300
MCLA1005V2-7R5-R	±5%	7.5	8	0.4	100	50	3700	300
MCLA1005V2-8R2-R	±5%	8.2	8	0.4	100	50	3600	300
MCLA1005V2-9R1-R	±5%	9.1	8	0.4	100	50	3400	300
MCLA1005V2-100-R	±5%	10	8	0.4	100	50	3200	300
MCLA1005V2-120-R	±5%	12	8	0.5	100	50	2700	300
MCLA1005V2-150-R	±5%	15	8	0.5	100	50	2300	300
MCLA1005V2-180-R	±5%	18	8	0.6	100	50	2100	300
MCLA1005V2-200-R	±5%	20	8	0.6	100	50	2000	300
MCLA1005V2-220-R	±5%	22	8	0.6	100	50	1900	300
MCLA1005V2-270-R	±5%	27	8	0.7	100	50	1600	300
MCLA1005V2-330-R	±5%	33	8	0.8	100	50	1300	200
MCLA1005V2-390-R	±5%	39	8	1	100	50	1200	200
MCLA1005V2-430-R	±5%	43	8	1.1	100	50	1100	200
MCLA1005V2-470-R	±5%	47	8	1.1	100	50	1000	200
MCLA1005V2-560-R	±5%	56	8	1.2	100	50	750	200
MCLA1005V2-680-R	±5%	68	8	1.4	100	50	750	180
MCLA1005V2-820-R	±5%	82	8	2.4	100	50	750	150
MCLA1005V2-101-R	±5%	100	8	2.6	100	50	700	150
MCLA1005V2-121-R	±5%	120	8	2.8	100	50	600	150

1. Test frequency and voltage is for open circuit inductance (OCL) and Q at +25 °C  
2. Rated I: When rated I is applied to the product, self-temperature rise will be 20 °C or less.

3. Part Number Definition: MCLA1005V2-xxx-R  
MCLA1005V2 = Product code and size  
xxx= inductance value in nH, R= decimal point,  
If no R is present then last character equals number of zeros  
-R suffix = RoHS compliant

Part number	OCL Tolerance	OCL (nH)	Q minimum	DCR@ (+25 °C) maximum	Test frequency (MHz)	Test voltage (mV)	SRF (MHz) minimum	I Rated (mA)
MCLA1005V2-151-R	±5%	150	8	3.2	100	50	550	100
MCLA1005V2-181-R	±5%	180	8	3.7	100	50	500	100
MCLA1005V2-221-R	±5%	220	8	4.0	100	50	450	100
MCLA1005V2-271-R	±5%	270	8	4.5	100	50	400	100
MCLA1005V2-331-R	±5%	330	6	7.0	50	50	350	50

1. Test frequency and voltage is for open circuit inductance (OCL) and Q at +25 °C  
2. Rated I: When rated I is applied to the product, self-temperature rise will be 20 °C or less.

3. Part Number Definition: MCLA1005V2-xxx-R  
MCLA1005V2 = Product code and size  
xxx= inductance value in nH, R= decimal point,  
If no R is present then last character equals number of zeros  
-R suffix = RoHS compliant

**Mechanical parameters, schematic, pad layout (mm)**

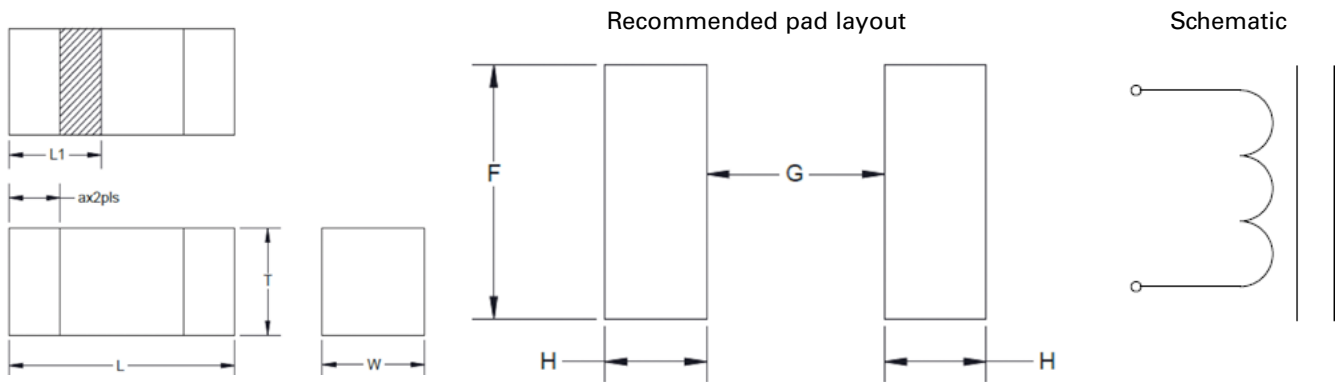

Part Number	L	W	T	A	L1	F	G	H
MCLA1005V2-xxx-R	1.00±0.15	0.50±0.15	0.50±0.15	0.25±0.10	0.50±0.15	0.85 ref	0.15 ref	0.75 ref

Part marking: No marking  
All soldering surfaces to be coplanar within 0.1 millimeters  
Tolerances are ±0.1 millimeters unless stated otherwise  
Dimension L1 is for orientation  
Pad layout dimensions are reference only  
Traces or vias underneath the inductor is not recommended

**Packaging information (mm)**

Drawing not to scale

Supplied in tape and reel packaging, 10000 parts per 7" diameter reel

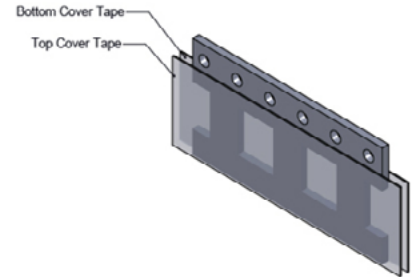
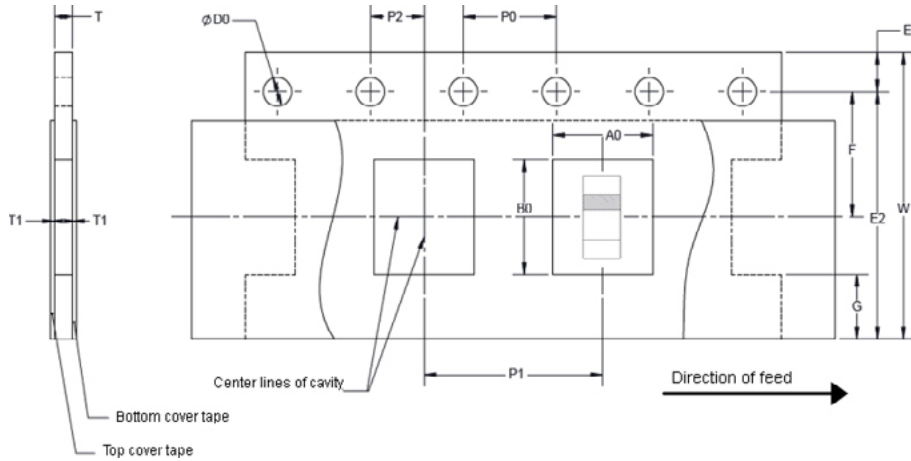

$W \pm 0.2$	8.00
$F \pm 0.1$	3.50
$E1 \pm 0.2$	1.75
E2 Min	na
$P0 \pm 0.2$	4.00
$P1 \pm 0.1$	2.00
$P2 \pm 0.1$	2.00
$D0 \pm 0.1$	1.55
A0	$0.65 \pm 0.1$
B0	$1.15 \pm 0.1$
T	$0.6 \pm 0.1$
T1 Max	na

Inductance and Q vs frequency

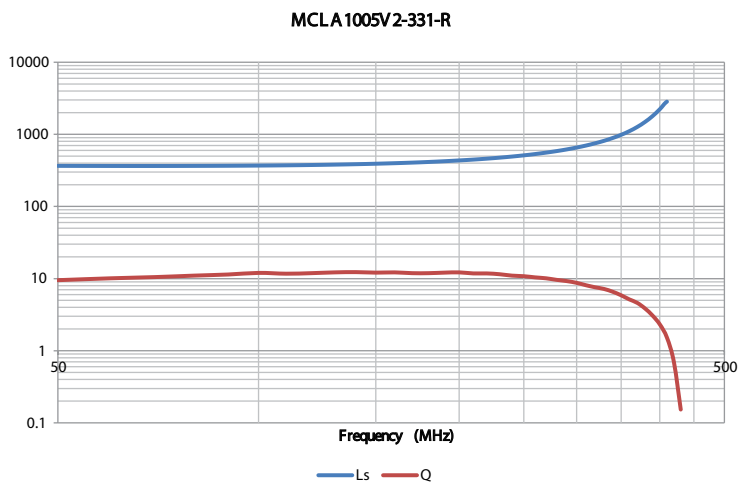
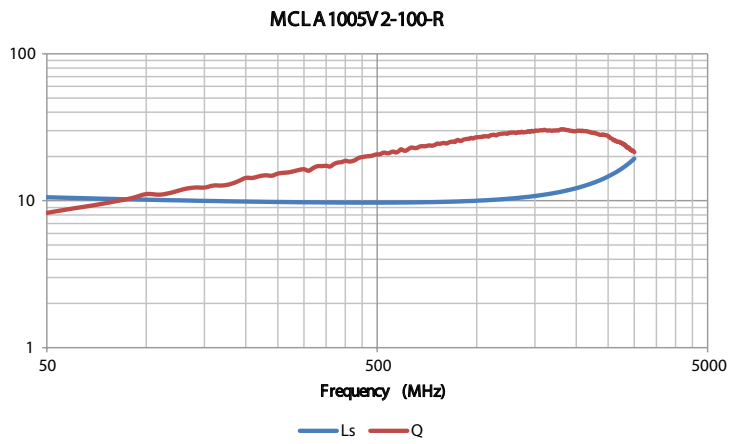
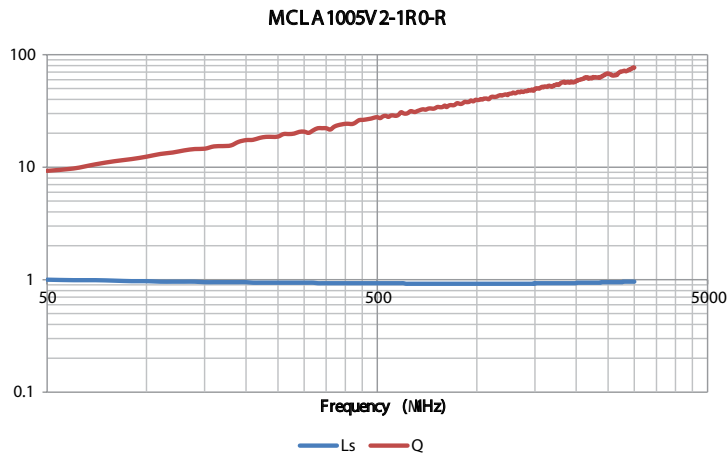

**Solder reflow profile**

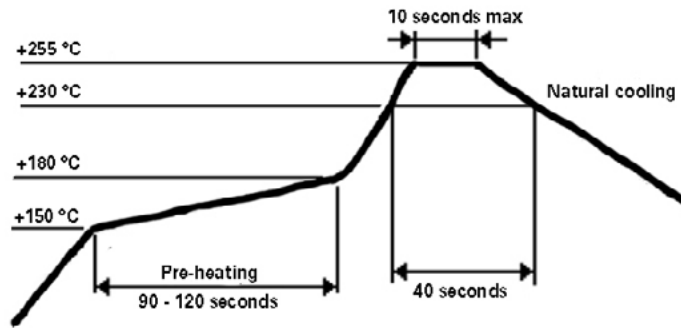

Life Support Policy: Eaton does not authorize the use of any of its products for use in life support devices or systems without the express written approval of an officer of the Company. Life support systems are devices which support or sustain life, and whose failure to perform, when properly used in accordance with instructions for use provided in the labeling, can be reasonably expected to result in significant injury to the user.

Eaton reserves the right, without notice, to change design or construction of any products and to discontinue or limit distribution of any products. Eaton also reserves the right to change or update, without notice, any technical information contained in this bulletin.

**Eaton**  
**Electronics Division**  
1000 Eaton Boulevard  
Cleveland, OH 44122  
United States  
Eaton.com/electronics

© 2019 Eaton  
All Rights Reserved  
Printed in USA  
Publication No. 10974 BU-MC19102  
November 2019

Eaton is a registered trademark.  
All other trademarks are property  
of their respective owners.

Follow us on social media to get the  
latest product and support information.

